



Dual PTZ IP Camera (Thermal/Visual)

NVIP-2DPT-8721/30/T



FUNCTIONS



COMPATIBILITY



KEY FEATURES

- Resolution: 4 MPX
- Lens: motorized varifocal, AI and AF function, optical zoom 30x, f=5.3 ~ 159 mm/F1.6 ~ 4.3
- lens: thermal fixed focal length, f=25 mm/F1.0
- D/N function - IR cut filter
- Video content analysis based on Deep Learning
- WDR with double scan sensor
- Temperature Measurement - Thermal Module.
- Temperature Alarm - Thermal Module
- Ability to observe in total darkness - Thermal Module
- two-way audio
- Min. Illumination from 0.001 lx

DIMENSIONS

Image - Thermal Module	
Image Sensor	Uncooled FPA Microbolometer
Number of Effective Pixels	400 (H) x 300 (V)
Pixel Size	17 µm
Spectral Range	8 - 14 µm
Thermal Sensitivity	40 mK
Thermovision Modes	White Hot, Black Hot, Rainbow, Ironbow, HSV, Autumn, Bone, Cool, Copper, Fire Hot, Pink, Spring, Summer, Winter, Jet, Flame, Rosebengal
Detection Temperature	-20°C ~ 150°C
Digital Noise Reduction (DNR)	2D, 3D
Lens - Thermal Module	
Lens Type	fixed focal length, f=25 mm/F1.0, with manual focus
Object Detection Range	735m - human , 2255m - vehicle , 735m - fire
Object Recognition Range	184m - human , 564m - vehicle
Image	
Image Sensor	4 MPX CMOS sensor 1/2.8" SONY
Number of Effective Pixels	2592 (H) x 1520 (V)
Min. Illumination	0.01 lx/F1.2 - color mode, 0.001 lx/F1.2 - B/W mode
Electronic Shutter	auto: 1/5 s ~ 1/20000 s
Digital Slow Shutter (DSS)	up to 1/5 s
Wide Dynamic Range (WDR)	yes (double scan sensor)
Digital Image Stabilization (DIS)	yes
Digital Noise Reduction (DNR)	3D
Defog Function (F-DNR)	yes
Highlight Compensation (HLC)	yes
Back Light Compensation (BLC)	yes
Lens	
Optical Zoom	30x
Lens Type	motorized, auto-iris function, f=5.3 ~ 159 mm/F1.6 ~ F4.3
Auto-focus	zoom trigger, manual trigger
Day/Night	
Switching Type	mechanical IR cut filter
Switching Mode	auto, time
Switching Level Adjustment	yes
Switching Delay	0 ~ 180 s
Network	
Stream Resolution	2560 x 1440 (QHD), 2592 x 1520, 2304 x 1296, 1920 x 1080 (Full HD), 1280 x 720 (HD), 720 x 576 (D1), 640 x 480 (VGA), 352 x 288 (CIF), 320 x 240 (QVGA) for thermal module: 704 x 576, 352 x 240
Frame Rate	30 fps for each resolution
Multistreaming Mode	3 streams (main stream, sub stream, third stream)
Video/Audio Compression	H.264, H.265, MJPEG/G.711, RAW_PCM
Number of Simultaneous Connections	max. 10
Network Protocols Support	HTTP, TCP/IP, IPv4/IPv6, UDP, DHCP, DNS, RTSP, RTP, IEEE 802.1X, PPPoE, SMTP, RTCP, HTML5
Camera Configuration	from Edge, Firefox, Chrome browser languages: Polish, English, and others
Compatible Software	NOVUS MANAGEMENT SYSTEM VSS
PTZ	
Preset Commands	400
Tours	12 (up to 32 presets per tour)
Auto-Scans	8
Patterns	6
Tilt/Pan Range	-90° ~ 90°/360° (continuous)
Pan/Tilt Speed	up to 60°/s (proportional to zoom)
Preset Speed	up to 60°/s
Other functions	
Temperature Measurement	yes - for thermal module
Temperature Alarm	yes - for thermal module
Temperature Measurement Zones	20 - for thermal module polygon, line, point
Temperature Measurement Accuracy	+2°C / +2%
Privacy Zones	4 video mask type: single color
Motion Detection	yes
Region of interest (ROI)	8
Audio Detection	yes
Video Content Analysis (VCA)	line cross, zone entrance, zone exit, double line cross, loiter, converse, objects distinguishing, people counting for thermal module: fire detection, temperature measurement, fire source detection, smoke detection
Image Processing	Defective Pixel Correction (DPC), mirror effect, vertical flip, horizontal flip
System Reaction to Alarm Events	e-mail with attachment, saving file on FTP server, alarm output activation, playback of the audio message
Restoring default settings	via web browser
Interfaces	
Video Output	BNC, 1.0 Vp-p, 75 Ohm
Audio Input/Output	2 x Jack (3.5 mm)/2 x Jack (3.5 mm)

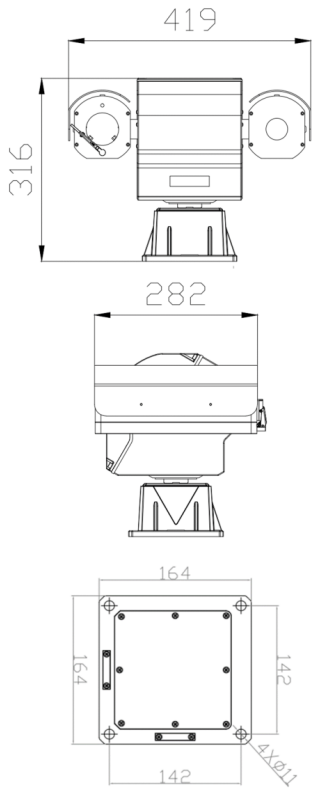

Alarm Input/Output	9 (NO/NC)/4
Network Interface	1 x Ethernet - RJ-45 interface, 10/100 Mbit/s
Installation parameters	
Dimensions (mm)	with bracket: 419 (W) x 316 (H) x 282 (L) 4 m long connection cables
Weight	16.5 kg
Degree of Protection	IP 66 (details in the user's manual)
Enclosure	aluminium, white,
Power Supply	36 VDC (power supply included)
Power Consumption	80 W
Operating Temperature	-40°C ~ 60°C
Humidity	max. 90%, relative (non-condensing)
Built-in Heater/Fan	yes/yes